

Explosion Flame Proof 3 Phase 7.5kW 10HP 4 Pole Electric Motor IMB3 Exd Ex d



Explosion Flame Proof 3 Phase 7.5kW 10HP 4 Pole Electric Motor IMB3 Exd Ex d

Approved to: Zone 1, Groups IIB or IIC, T4 Class Temperature, Ex D Area

Please note: This item requires a minimum of 5 business days for handling. Additionally, kindly note that all the photos provided are for illustrative purposes only.

Explosion Proof Three 3 Phase Electric 7.5kW 10HP 4 Pole B3 Electric Motor

Specifications:

- Power: 7.5Kw (10HP)
- Voltage: 415V Three Phase 50Hz
- Speed: 4 Pole
- Shaft size: 38mm
- Duty: S1 continuous

kW	Frame	Shaft (mm)	Speed RPM	Full Load Current (A)	Locked Rotor Current Ist/IN	Efficiency %	Power Factor	Full Load (Nm)	Locked Rotor Tst/TN	Break Down Tmax/ TN	400V	380V	Moment of inertia J=1/2GD ² (kg m ²)	Weight of foot mount motor (Kgs)	Noise Level	Vibration
											Full Load Current (A)	Full Load Current (A)			No Load @ 1 Metre dB(A)	No Load mm/s
0.55	80A	19	1435	1.31	6.3	79	0.74	3.66	2.3	2.3	1.36	1.43	0.0016	29	58	1.3
0.75	80B	19	1435	1.81	6.2	82.5	0.7	4.99	2.4	2.7	1.87	1.97	0.002	30	58	1.3
1.1	90S	24	1435	2.49	6.6	84.1	0.73	7.32	2.3	2.7	2.59	2.72	0.003	37	61	1.3
1.5	90L	24	1440	3.35	6.4	85.3	0.73	9.95	2.6	3	3.48	3.66	0.0038	40	61	1.3
2.2	100LA	28	1455	4.65	8	86.7	0.76	14.4	2.5	3	4.82	5.07	0.0077	51	64	1.3
3	100LB	28	1455	5.95	7.6	87.7	0.8	19.7	2.6	3	6.17	6.5	0.0093	56	64	1.3
4	112M	28	1455	8.26	8.6	88.6	0.76	26.3	2.6	2.8	8.57	9.03	0.128	72	65	1.3
5.5	132S	38	1460	10.8	8.6	89.7	0.79	36	2.3	2.7	11.2	11.8	0.0295	90	67	1.3
7.5	132M	38	1460	14.6	8.3	90.4	0.79	49.1	2.4	2.9	15.2	16	0.0366	102	67	1.3
11	160M	42	1470	20.4	8.1	91.4	0.82	71.5	2.1	2.6	21.2	22.3	0.0795	148	71	1.8

Features:

- IEC Standard
- Ex Standard
- IP66 Protection Rating
- Cast iron construction with top mounted terminal box, high resistance to impact
- Class F insulation
- High Efficiency
- High quality bearings, grease packed for life
- Low noise and vibration

Suitable Applications:

- Hoists / Winches
- Compressors
- Conveyor Drives
- Pump Drives
- Automation Devices
- Food / Pharmacy Packaging
- Pulley drives
- Fans
- Food Processing
- Oil & Gas Applications
- Offshore & Marine Applications
- Chemical Applications
- Pharmaceutical Applications
- Gas Compressors
- Flameproof pumps

Optional Accessories (Available on request):

- IEC Flange/Foot Mounting
- Slide Rails
- Industrial Gearboxes
- Couplings
- Pulleys
- Chain Drives

Dimensions:

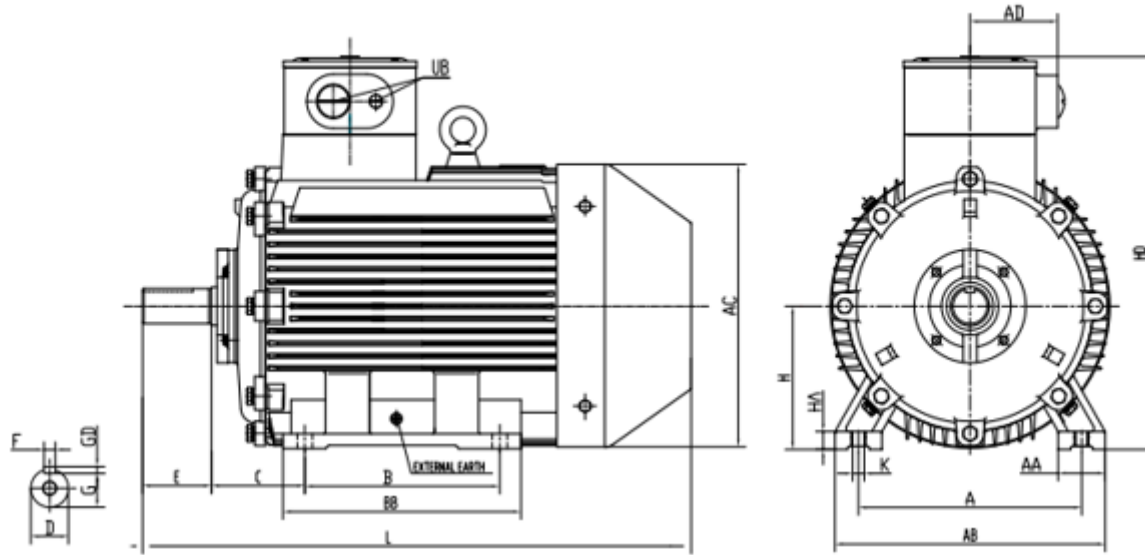

FRAME	A	B	C	D	DB	E	F	G	GD	H	K	AA	AB	AC	AD	BB	HA	HD	L	UB	
80	125	100	50	19	M6	40	6	15.5	6	80	10	34	165	170	100	130	10	320	330	1xM25	1xM20
90S	140	100	56	24	M8	50	8	20	7	90	10	36	180	185	100	135	14	330	370	1xM25	1xM21
90L	140	125	56	24	M8	50	8	20	7	90	10	36	180	185	100	160	14	330	395	1xM25	1xM22
100L	160	140	63	28	M10	60	8	24	7	100	12	43	205	210	100	180	14	360	448	1xM25	1xM23
112M	190	140	70	28	M10	60	8	24	7	112	12	50	240	225	125	180	16	380	500	1xM25	1xM24
132S	216	140	89	38	M12	80	10	33	8	132	12	60	280	265	125	190	18	430	550	1xM40	1xM25
132M	216	178	89	38	M12	80	10	33	8	132	12	60	280	265	125	230	18	430	600	1xM40	1xM26
160M	254	210	108	42	M16	110	12	37	8	160	14.5	70	320	320	125	260	20	500	720	1xM40	1xM27
160L	254	254	108	42	M16	110	12	37	8	160	14.5	70	320	320	125	310	20	500	750	1xM40	1xM28

Wiring (Wiring Diagram is located on the cap of the control box):

We also have both Single and Three Phase electric motors (non-explosion proof) between 0.18Kw to 315Kw in 2, 4, 6 and 8 pole.

We do not deliver to PO Boxes. Please make sure you have a residential address in your details for us to send your order to.

[Local Pick up from our Sydney, Prestons Warehouse available.](#)

You are buying from a professional Business with many years experience in this market. DO NOT compare this product with other cheaper prices or even same prices. This is a very high quality motor. Limited Time Offer. QUALITY at the right PRICE. This crazy price will not last long.

BUY NOW

Payments Methods Accepted

Listing Details

When making a purchase from any of our eBay listings you are entering into a contract governed by our terms & conditions below. Please ensure you have read these before making your purchase.

Images shown are for demonstration purposes only. Product will match description but may vary from images shown. For any concerns about how a product looks please contact us before ordering.

The item description/price/stock levels is accurate to our knowledge. All errors or omissions are unintentional. If problems are encountered, please contact us.

Payment

Full payment is required within 5 days of sale. Payment can be made by Cash on pick-up (from our Warehouse), Paypal, credit card (over the phone) or bank deposit. Items will not be shipped out unless payment has been made in full.

Shipping/Delivery/Pick up

Please refer to our shipping tab at the top of our listing for all freight costs and delivery times. Your order will be sent through one of our delivery partners which include Toll, TNT, Couriers Please, E-Go, Go Logistics and Australia Post. The service used to deliver your order will be automatically selected by our freighting system. We assume no liability for postal delays or lost/damaged parcels, but we will assist the buyer to locate or to obtain a replacement.

We require a valid street address for all deliveries. We do NOT deliver to PO Boxes, Parcel Lockers or Post Office addresses. We also require a daytime phone number for all orders. Our operation hours for dispatch are Monday to Friday 9am to 2:30pm. In the unlikely case that you do not receive your order, please contact us to resolve this.

Local Pickup from our Sydney, Prestons Warehouse available.

Warranty

Warranty periods are as follows:

- All remotes and receivers have 3 months warranty
- Garage door and gate motors have 12 months warranty
- All other products have 6 months warranty

If you have a problem with the product, please contact us through eBay and include the original purchase information (i.e. your name, address, email and purchase receipt number)

Warranty does not include damage caused by normal wear and tear, accidents, misuse, lack of maintenance, neglect, natural disaster, or other external causes; to damage caused by operating the equipment in a manner outside that described in the instructions. The warranty is considered void if the item has been modified, altered or tampered with by a person(s) not authorised by us to provide service (with the exception of standard periodic maintenance). Consumables and accessories such as chains, carry bags, batteries, hoses, grinding discs, belts, cables, wheels, blades, tubs, pads, nets etc. are also not covered once used or for damage caused by general wear and tear.

Until the nature of any fault is determined, the resolution we can offer may vary. To assist with a quick resolution, photos of the damaged part/unit will be required for verification. We will repair or replace, at our discretion, any unit determined to be within the warranty period. Where necessary, the item may need to be returned to repair the fault/issue.

The buyer will be liable for all shipping costs associated with any warranty claim.

All returns for warranty must first be authorised in writing by our Customer Service Team and given a Return Authorisation Number (RAN). We will not accept the return of any item/s without a Return Authorisation Number (RAN).

When a return is authorised, it is the buyer's responsibility to ensure the product is packaged securely to prevent any damage during the return process. Failure to do so may affect the resolution to be offered, which may include repairs, replacement items or store credit at our discretion.

For all warranty claims, the outcome of the inspection should take no longer than 10 business days from the date the item is received by our service department (times may vary).

Warranty claims will not be accepted in cases where the buyer has contributed to the failure, or been misleading in their description of their issues. In these instances, where freight costs were incurred by us to return your item for inspection, reimbursement to us may be required prior to releasing the goods. The item is also to be returned to the buyer at the buyer's expense. Freight cost not to exceed original freight cost. Payment is to be made to us within 7 days of being notified of warranty rejection. Storage fees to apply beyond 7 days at 5% per week of the original product cost until the credit expires. Where money is owed to us for repairs and/or postage, we will be entitled to hold onto the item until payment is made.

Returns/Exchanges

Returns or exchanges must be made within 7 days of the delivery date. After 7 days, any claims of delivery errors or requests for returns or exchanges will not be accepted.

Products may be returned/exchanged provided that the item(s) are returned in an unused, clean, sellable condition with original packaging, subject to our discretion.

If the item has sustained damage in transit, or is not returned as noted above, a revised refund amount may be required.

All returns will be refunded less the delivery cost. All exchanges will incur a return delivery fee.

We reserve the right as final authority on whether the products should be refunded or replaced and make no other warranty and no implied warranties, including any warranty of merchantability or fitness for a particular purpose. Our maximum liability hereunder is limited to the purchase price of the products. In no event shall we be liable for any consequential, indirect, incidental or special damages of any nature arising from the sale of the product.

If you accept these terms and wish to return an item, please send us a message stating your name, order number, the item(s) you wish to return, and the reason for the return. Our Customer Service team will respond to your email and, if applicable, written authorisation for the return will be given. All other relevant information will also be given to you at this time. We will not accept the return of any item(s) without our prior authorisation.

Contact Us

If you have any questions or enquiries, please do not hesitate to send us a message through eBay.

Feedback

At MTM we strive to maintain an excellent customer service so if you have any issues or inquiries about your purchase, please feel free to contact us before leaving feedback and we would be happy to help. Please do not leave negative feedback before contacting us.

Any negative feedback left without any contact will be regarded as an indication of the conclusion of the transaction.

By placing a bid or buying, you have agreed to all the conditions mentioned above.