

4 Bolt Flange Pillow Block Bearing Self Aligning Foot Housing 55mm Bore

4 Bolt Flange Pillow Block Bearing 55mm Bore



4 Bolt Flange Pillow Block Bearing

The bearings consist of a self-aligning feature, so it allows the bearings' inner ring and outer ring to have a specific angle. Pillow block bearings are widely used in machinery systems such as, pharmaceutical, food, printing machines, motorcycles, motors, pumps, fans, air conditioners and many more.

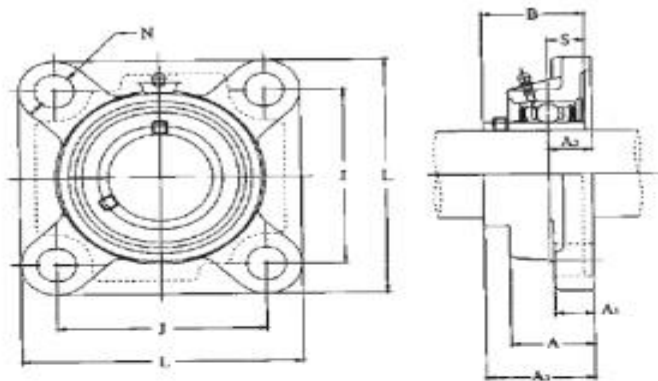

Shaft Diameter (mm)	UNIT Number	Dimensions (mm)									Weight kg
		L	A	J	A1	A2	N	A3	B	S	
12	UCF201	86	25.5	64	12	15	12	33.3	31.0	12.7	0.67
15	UCF202	86	25.5	64	12	15	12	33.3	31.0	12.7	0.66
17	UCF203	86	25.5	64	12	15	12	33.3	31.0	12.7	0.64
20	UCF204	86	25.5	64	12	15	12	33.3	31.0	12.7	0.62
25	UCF205	95	27.0	70	14	18	12	35.7	34.1	14.3	0.83
30	UCF206	108	31.0	83	14	18	12	40.2	38.1	15.9	1.14
35	UCF207	117	34.0	92	16	19	14	44.4	42.9	17.5	1.47
40	UCF208	130	36.0	102	16	21	16	51.2	49.2	19.0	2.00
45	UCF209	137	38.0	105	18	22	16	52.2	49.2	19.0	2.40
50	UCF210	143	40.0	111	18	22	16	54.6	51.6	19.0	2.60
55	UCF211	162	43.0	130	20	25	19	58.4	55.6	22.2	3.60
60	UCF212	175	48.0	143	20	29	19	68.7	65.1	25.4	4.80
65	UCF213	187	50.0	149	20	30	19	69.7	65.1	25.4	5.80
70	UCF214	193	54.0	152	24	31	19	75.4	74.6	30.2	6.60
75	UCF215	200	56.0	159	24	34	19	78.5	77.8	33.3	7.70
80	UCF216	208	58.0	165	24	34	23	83.3	82.6	33.3	8.20
85	UCF217	220	63.0	175	26	36	23	87.6	85.7	34.1	9.60
90	UCF218	235	68.0	187	26	40	23	96.3	96.0	39.7	12.10

Includes:

- 1 x 4 Bolt Flange Bearing

We do not deliver to PO Boxes. Please make sure you have a residential address in your details for us to send your order to.

[Local Pick up from our Sydney, Prestons Warehouse available.](#)

You are buying from a professional Business with many years experience in this market. DO NOT compare this product with other cheaper prices or even same prices. This is commercial quality. Limited Time Offer. QUALITY at the right PRICE. This crazy price will not last long.

Payment Methods Accepted



Listing Details

When making a purchase from any of our eBay listings you are entering into a contract governed by our terms & conditions below. Please ensure you have read these before making your purchase.

Images shown are for demonstration purposes only. Product will match description but may vary from images shown. For any concerns about how a product looks please contact us before ordering.

The item description/price/stock levels is accurate to our knowledge. All errors or omissions are unintentional. If problems are encountered, please contact us.

Payment

Full payment is required within 5 days of sale. Payment can be made by Cash on pick-up (from our Warehouse), Paypal, credit card (over the phone) or bank deposit. Items will not be shipped out unless payment has been made in full.

Shipping/Delivery/Pick up

Please refer to our shipping tab at the top of our listing for all freight costs and delivery times. Your order will be sent through one of our delivery partners which include Toll, TNT, Couriers Please, E-Go, Go Logistics and Australia Post. The service used to deliver your order will be automatically selected by our freighting system. We assume no liability for postal delays or lost/damaged parcels, but we will assist the buyer to locate or to obtain a replacement.

We require a valid street address for all deliveries. We do NOT deliver to PO Boxes, Parcel Lockers or Post Office addresses. We also require a daytime phone number for all orders. Our operation hours for dispatch are Monday to Friday 9am to 2:30pm. In the unlikely case that you do not receive your order, please contact us to resolve this.

Local Pickup from our Sydney, Prestons Warehouse available.

Warranty

Warranty periods are as follows:

- All remotes and receivers have 3 months warranty
- Garage door and gate motors have 12 months warranty
- All other products have 6 months warranty

If you have a problem with the product, please contact us through eBay and include the original purchase information (i.e. your name, address, email and purchase receipt number)

Warranty does not include damage caused by normal wear and tear, accidents, misuse, lack of maintenance, neglect, natural disaster, or other external causes; to damage caused by operating the equipment in a manner outside that described in the instructions. The warranty is considered void if the item has been modified, altered or tampered with by a person(s) not authorised by us to provide service (with the exception of standard periodic maintenance). Consumables and accessories such as chains, carry bags, batteries, hoses, grinding discs, belts, cables, wheels, blades, tubs, pads, nets etc. are also not covered once used or for damage caused by general wear and tear.

Until the nature of any fault is determined, the resolution we can offer may vary. To assist with a quick resolution, photos of the damaged part/unit will be required for verification. We will repair or replace, at our discretion, any unit determined to be within the warranty period. Where necessary, the item may need to be returned to repair the fault/issue.

The buyer will be liable for all shipping costs associated with any warranty claim.

All returns for warranty must first be authorised in writing by our Customer Service Team and given a Return Authorisation Number (RAN). We will not accept the return of any item/s without a Return Authorisation Number (RAN).

When a return is authorised, it is the buyer's responsibility to ensure the product is packaged securely to prevent any damage during the return process. Failure to do so may affect the resolution to be offered, which may include repairs, replacement items or store credit at our discretion.

For all warranty claims, the outcome of the inspection should take no longer than 10 business days from the date the item is received by our service department (times may vary).

Warranty claims will not be accepted in cases where the buyer has contributed to the failure, or been misleading in their description of their issues. In these instances, where freight costs were incurred by us to return your item for inspection, reimbursement to us may be required prior to releasing the goods. The item is also to be returned to the buyer at the buyer's expense. Freight cost not to exceed original freight cost. Payment is to be made to us within 7 days of being notified of warranty rejection. Storage fees to apply beyond 7 days at 5% per week of the original product cost until the credit expires. Where money is owed to us for repairs and/or postage, we will be entitled to hold onto the item until payment is made.

Returns/Exchanges

Returns or exchanges must be made within 7 days of the delivery date. After 7 days, any claims of delivery errors or requests for returns or exchanges will not be accepted.

Products may be returned/exchanged provided that the item(s) are returned in an unused, clean, sellable condition with original packaging, subject to our discretion.

If the item has sustained damage in transit, or is not returned as noted above, a revised refund amount may be required.

All returns will be refunded less the delivery cost. All exchanges will incur a return delivery fee.

We reserve the right as final authority on whether the products should be refunded or replaced and make no other warranty and no implied warranties, including any warranty of merchantability or fitness for a particular purpose. Our maximum liability hereunder is limited to the purchase price of the products. In no event shall we be liable for any consequential, indirect, incidental or special damages of any nature arising from the sale of the product.

If you accept these terms and wish to return an item, please send us a message stating your name, order number, the item(s) you wish to return, and the reason for the return. Our Customer Service team will respond to your email and, if applicable, written authorisation for the return will be given. All other relevant information will also be given to you at this time. We will not accept the return of any item(s) without our prior authorisation.

Contact Us

If you have any questions or enquiries, please send us a message.

Feedback

At MTM we strive to maintain an excellent customer service so if you have any issues or inquiries about your purchase, please feel free to contact us before leaving feedback and we would be happy to help. Please do not leave negative feedback before contacting us.

Any negative feedback left without any contact will be regarded as an indication of the conclusion of the transaction.

By placing a bid or buying, you have agreed to all the conditions mentioned above.